

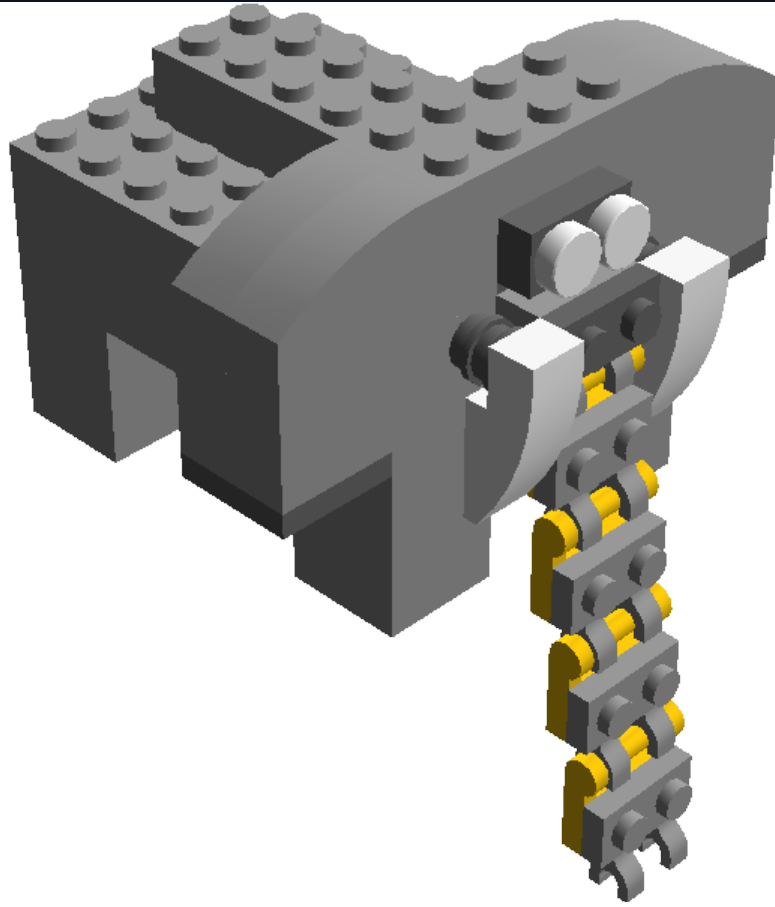

Model Name:
elephant

Number of Bricks: 62



Step 1 of 21

1 x

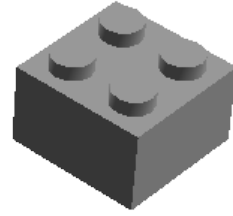

Step 2 of 21

1 x



2 x



1 x

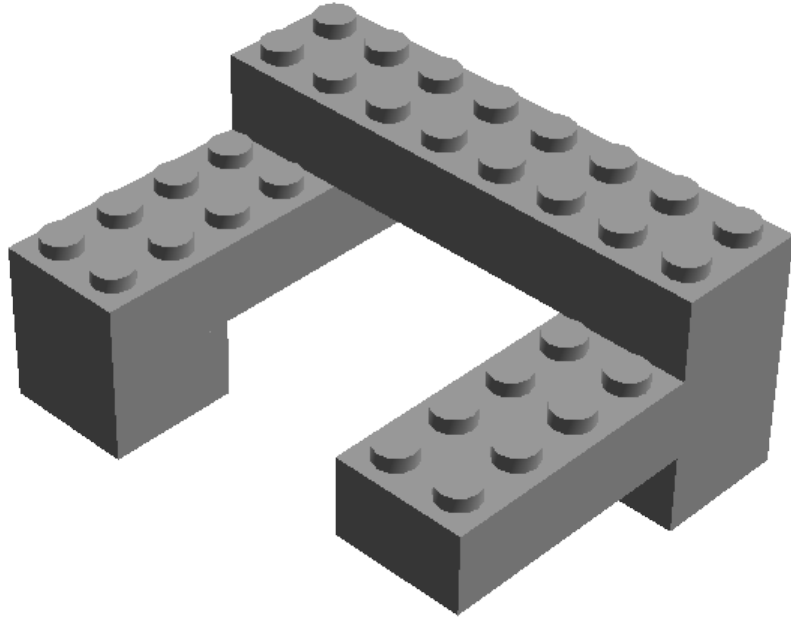

Step 3 of 21

2 x



1 x



1 x

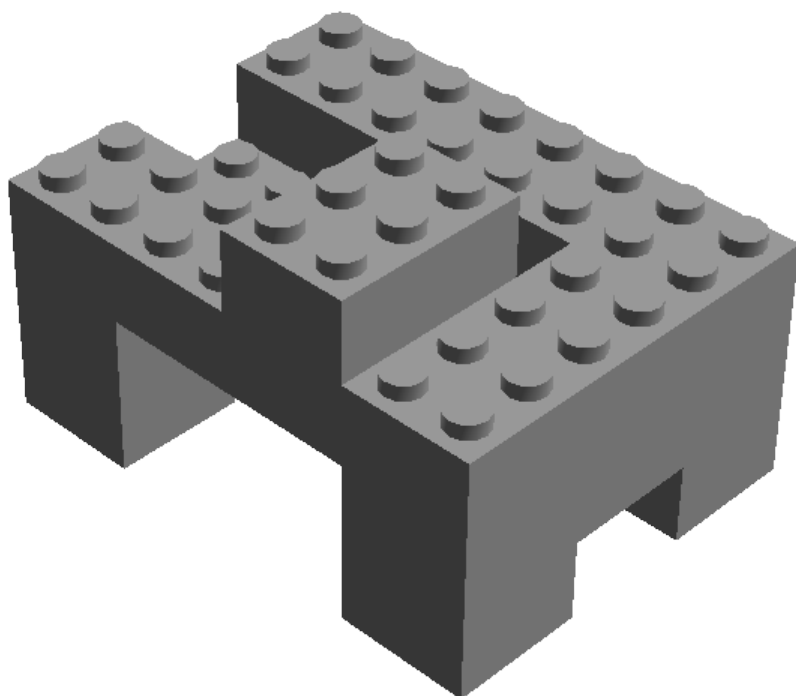

Step 4 of 21

1 x



3 x

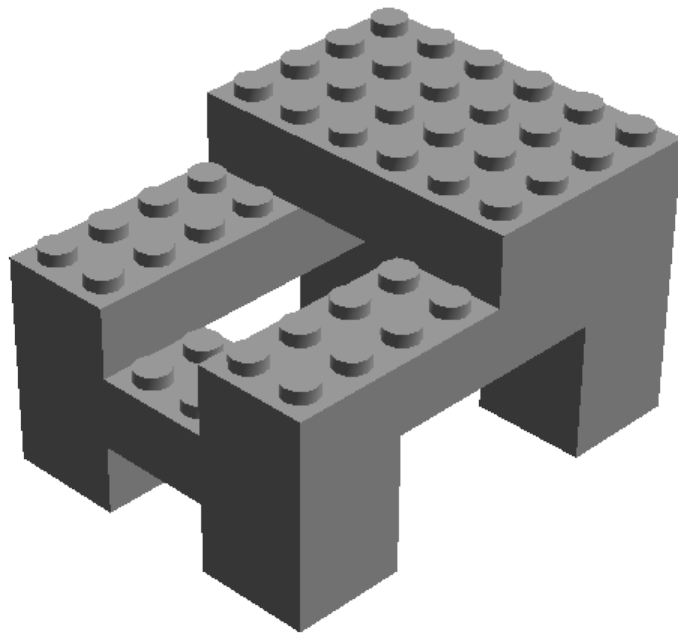

Step 5 of 21

1 x



1 x



2 x

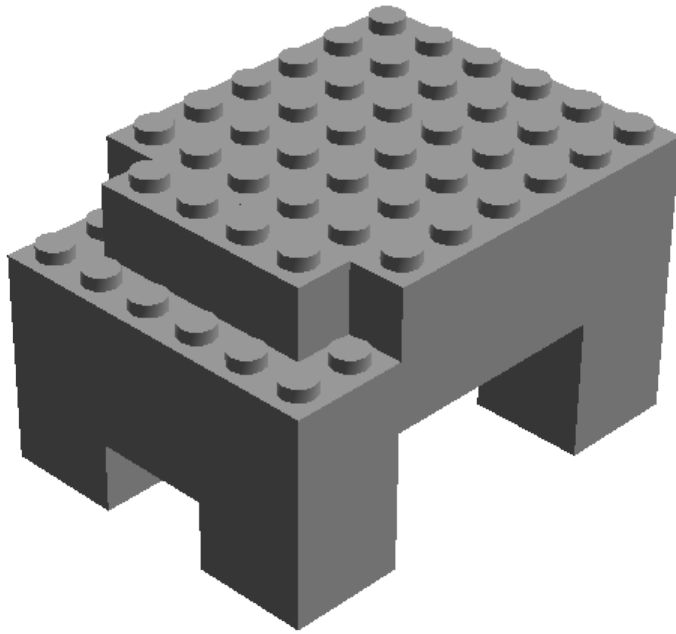

Step 6 of 21

2 x



1 x



1 x

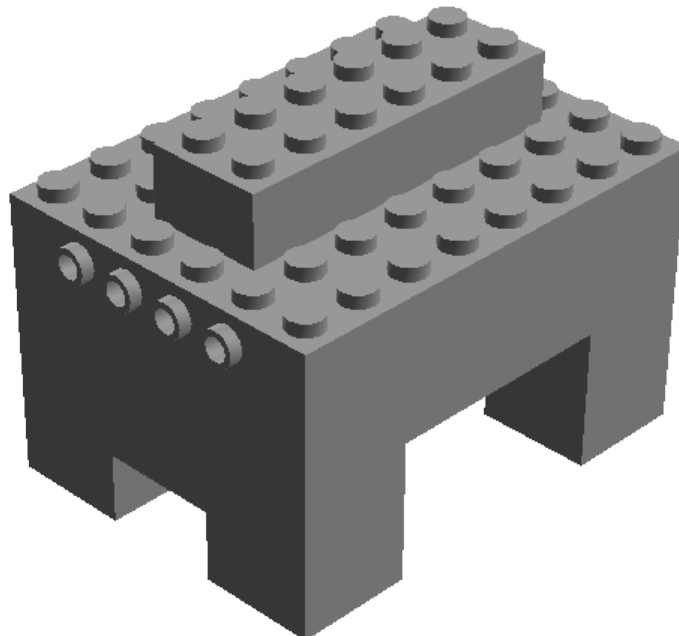

Step 7 of 21

1 x



3 x

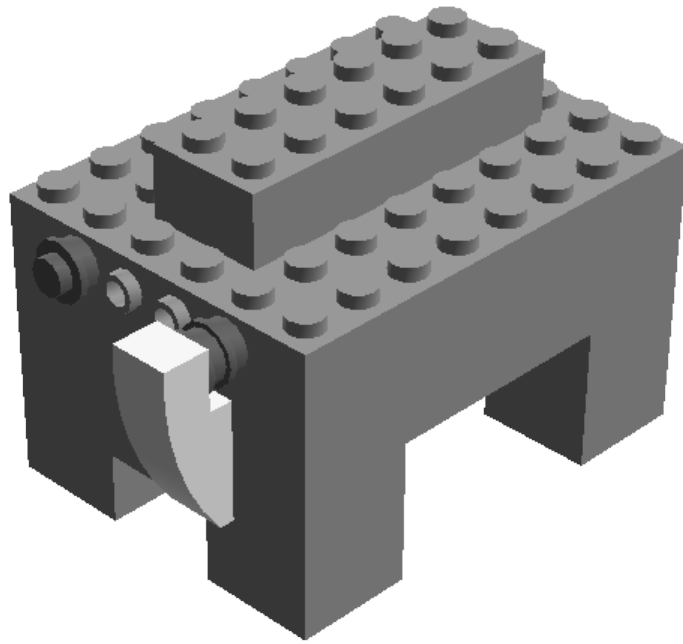

Step 8 of 21

1 x



1 x



1 x



1 x

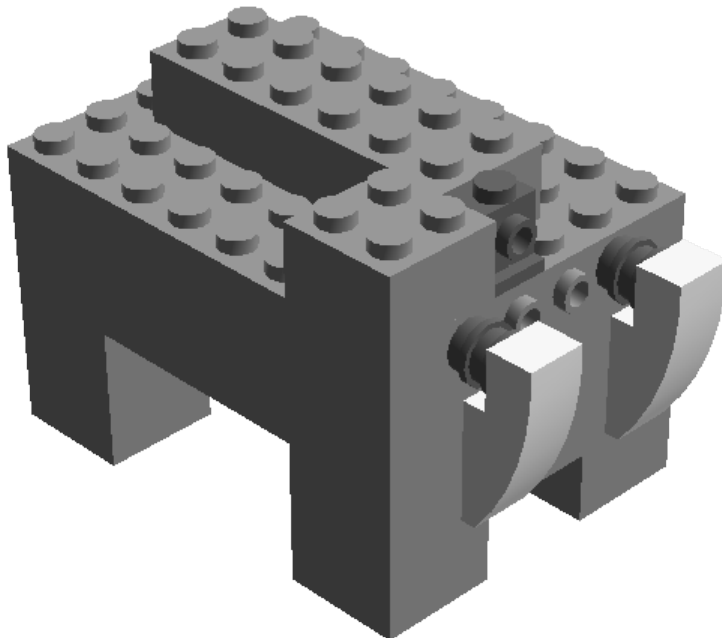

Step 9 of 21

1 x



1 x



2 x

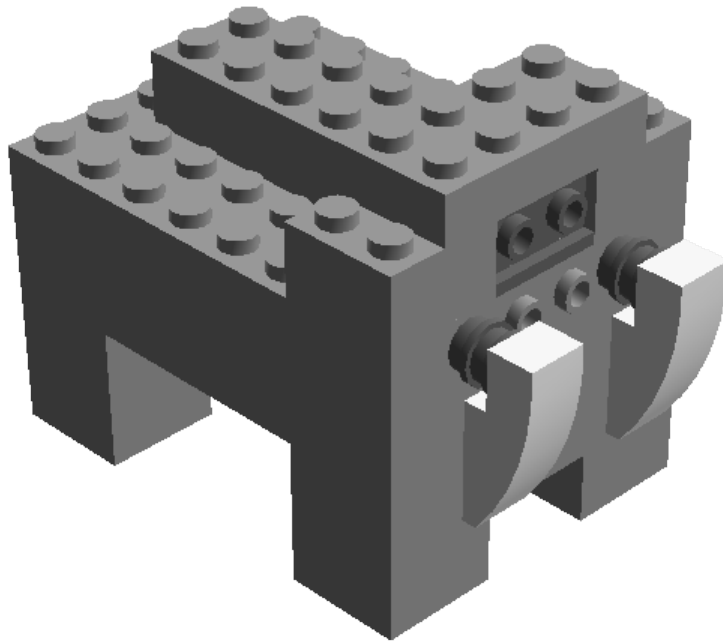

Step 10 of 21

2 x



2 x

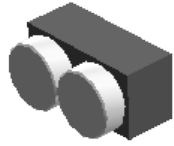

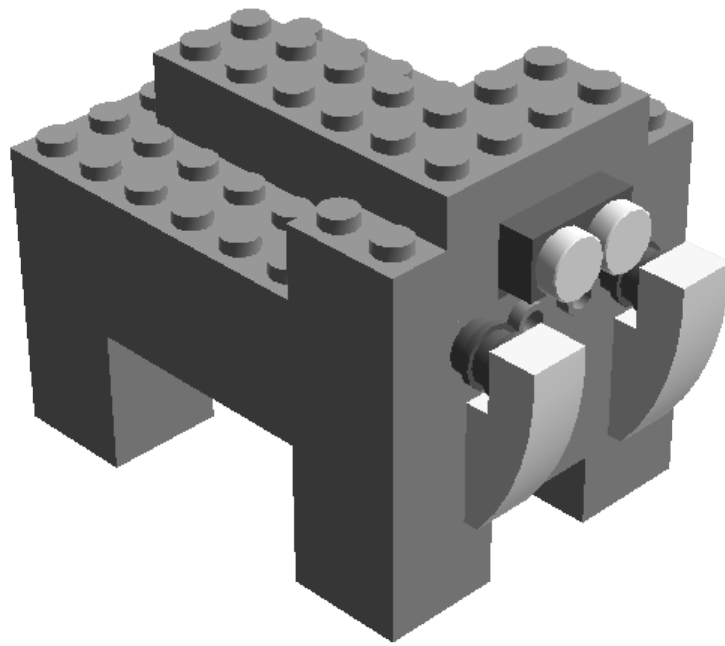

Step 12 of 21

2 x



1 x

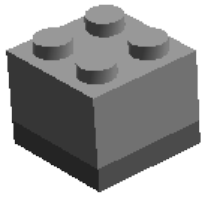

Step 13 of 21

2 x



2 x

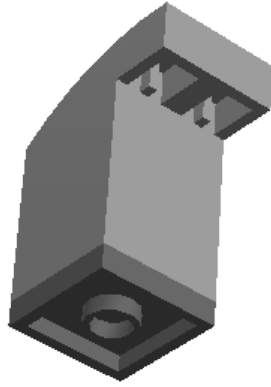

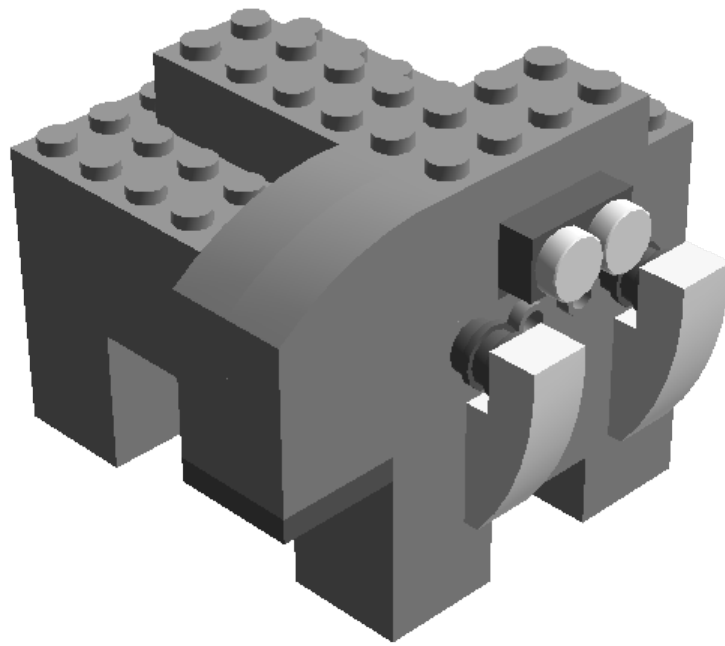

Step 15 of 21

2 x



1 x

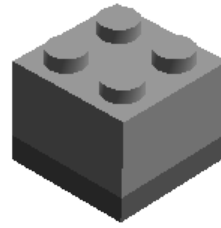

Step 16 of 21

2 x



2 x

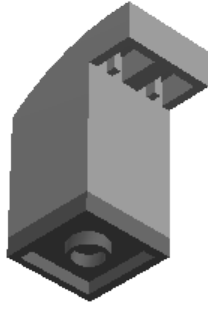

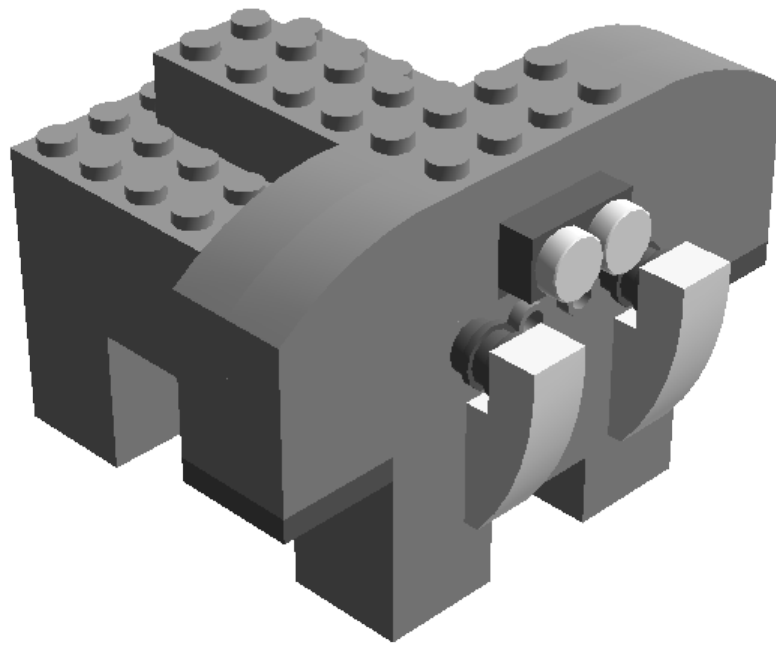

Step 18 of 21

1 x



2 x

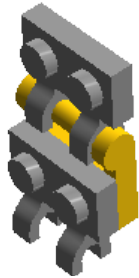

Step 19 of 21

2 x



2 x

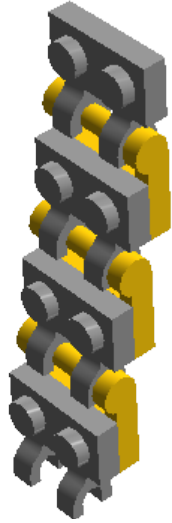

Step 20 of 21

1 x



1 x



1 x



1 x

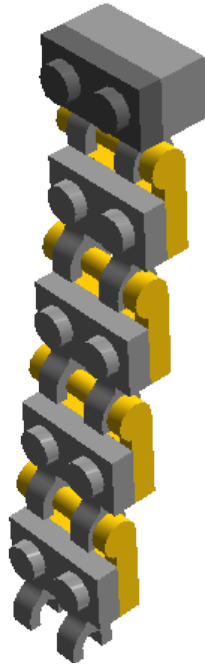

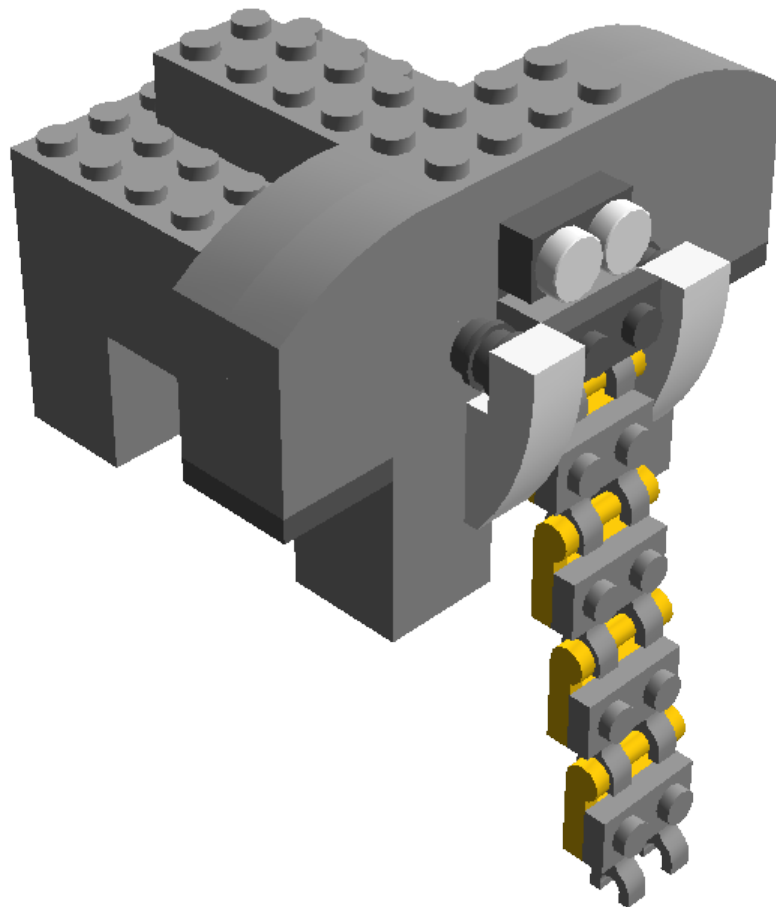

10 x  4211388 BRICK 1X2 - ??
Material194??

8 x  4211387 BRICK 2X2 - ??
Material194??

1 x  4211394 BRICK 1X4 - ??
Material194??

6 x  4211386 BRICK 2X3 - ??
Material194??

3 x  4211795 BRICK 2X6 - ??
Material194??

2 x  4211391 BRICK 2X8 - ??
Material194??

2 x  4211044 ANGULAR BRICK 1X1 - ??
Material199??

1 x  4211636 BRICK 1X4 W. 4 KNOBS
- ??Material194??

4 x  4251163 BRICK W/BOW 1/3 - ??
Material194??

2 x  4249112 BRICK W/BOW 1/3 - ??
Material1??

3 x  4211063 PLATE 1X2 - ??
Material199??

1 x  4211398 PLATE 1X2 - ??
Material194??

2 x  4211094 PLATE 2X2 - ??
Material199??

2 x  4211395 PLATE 2X4 - ??
Material194??

2 x  4646844 FLAT TILE 1X1, ROUND
- ??Material1??

4 x  4210633 PLATE 1X1 ROUND - ??
Material199??

4 x  4501232 PLATE 1X2 W. STICK 3.18
- ??Material24??

5 x  4515173 PLATE 1X2 W/HOLDER,
VERTICAL - ??
Material194??

